

1

- Insérer les tourillons en bois C dans les trous sur les côtés

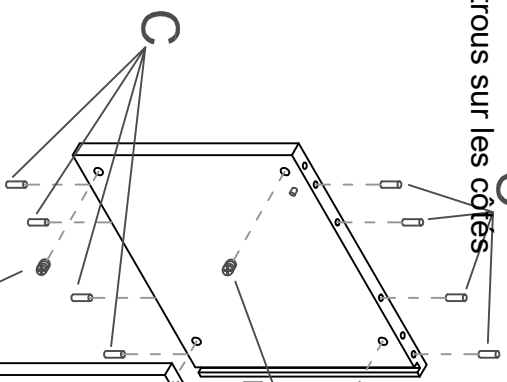

2

- Insérer les excentriques B et les tourillons C dans les côtés

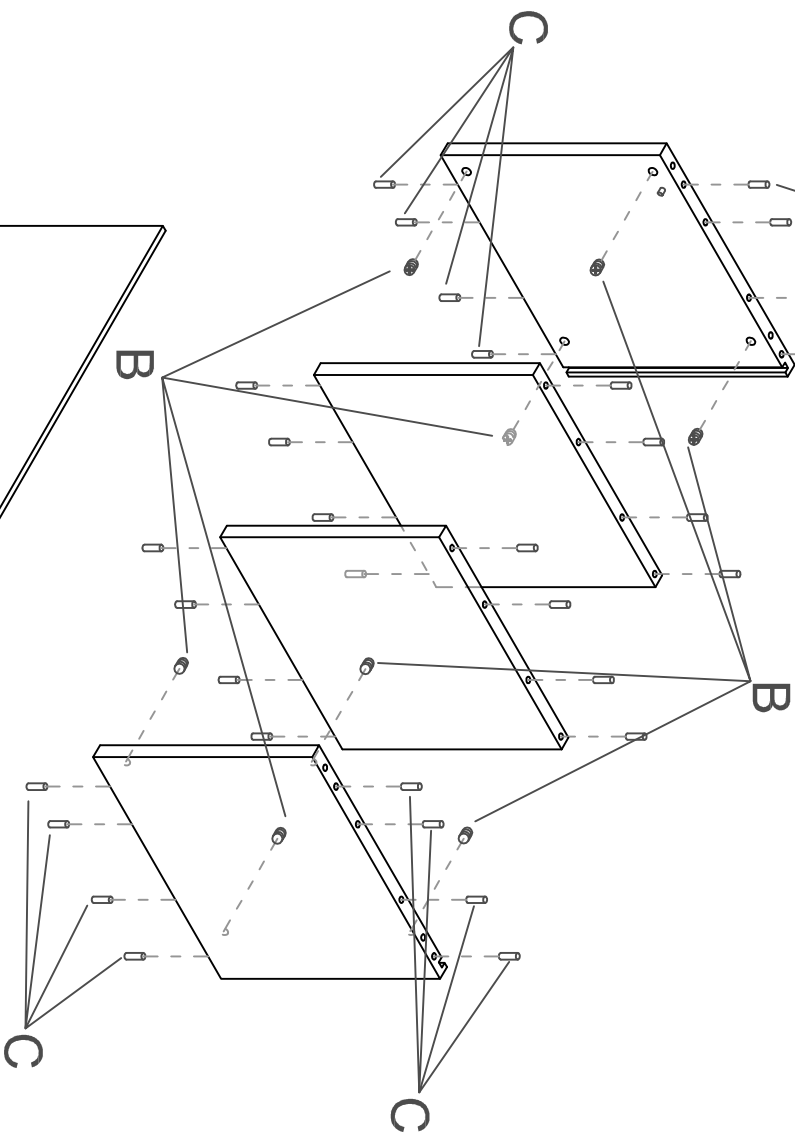

3

- Insérer les goujons A dans les bagues du plateau bas

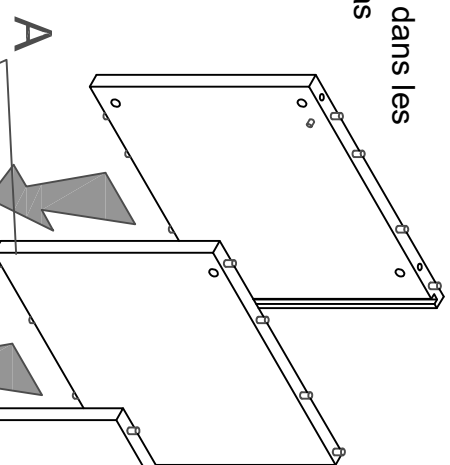

4

- Assembler les côtés avec le bas et serrer les excentriques B

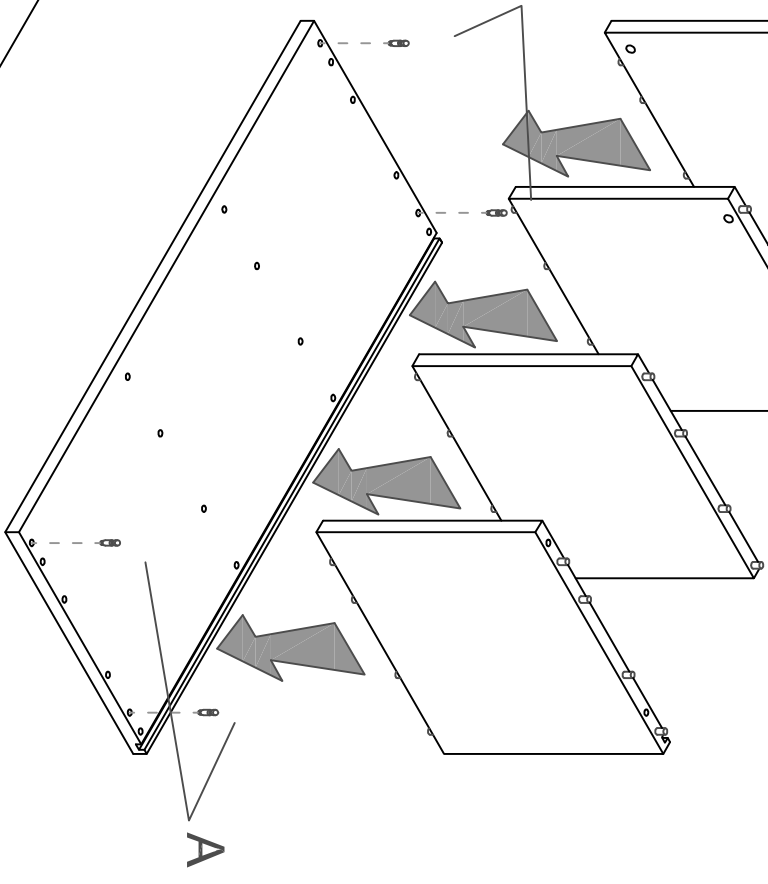

5

- Insérer le dos dans les rainures

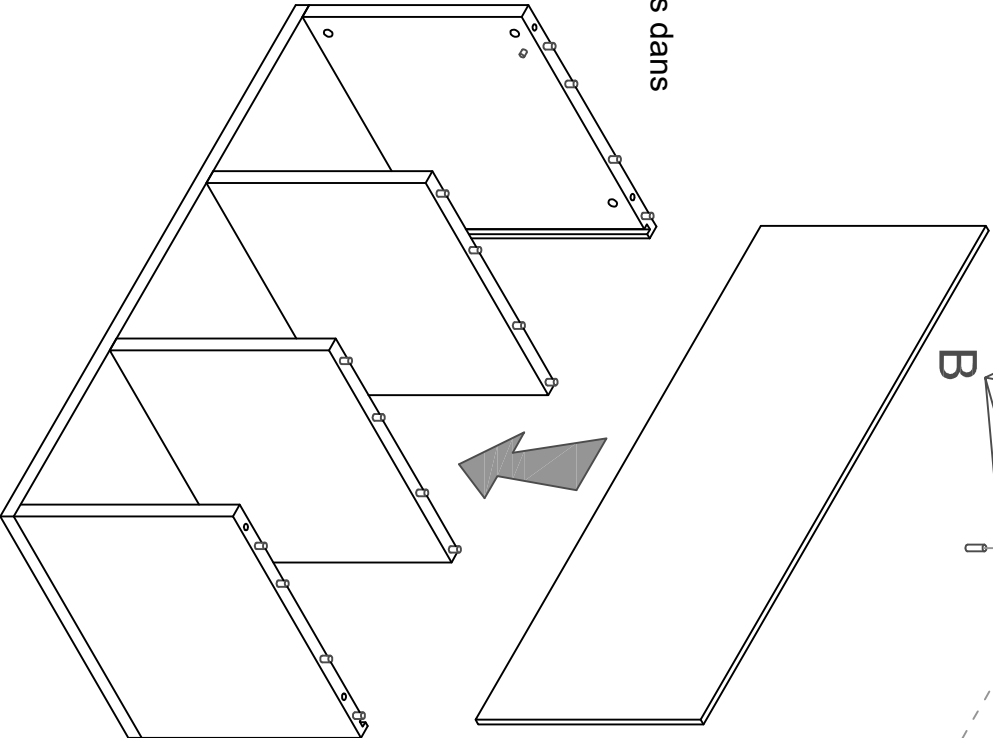

6

- Insérer les goujons A dans les bagues du plateau haut

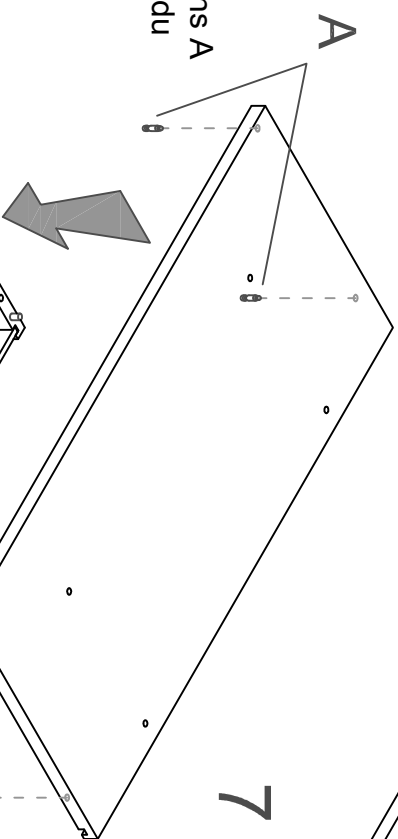

7

- Assembler le plateau en haut en resserrant les excentriques B

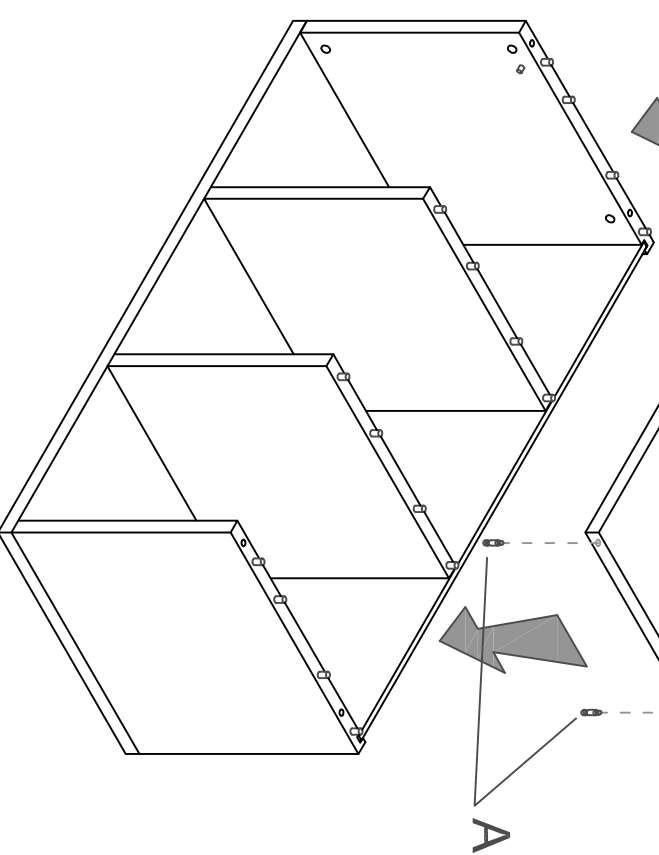

Q.ty 8

A

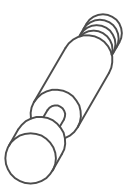

Goujon

Q.ty 8

B



Excentrique

Q.ty 24

C

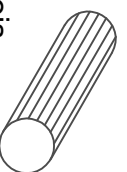

Tourillon en bois

1

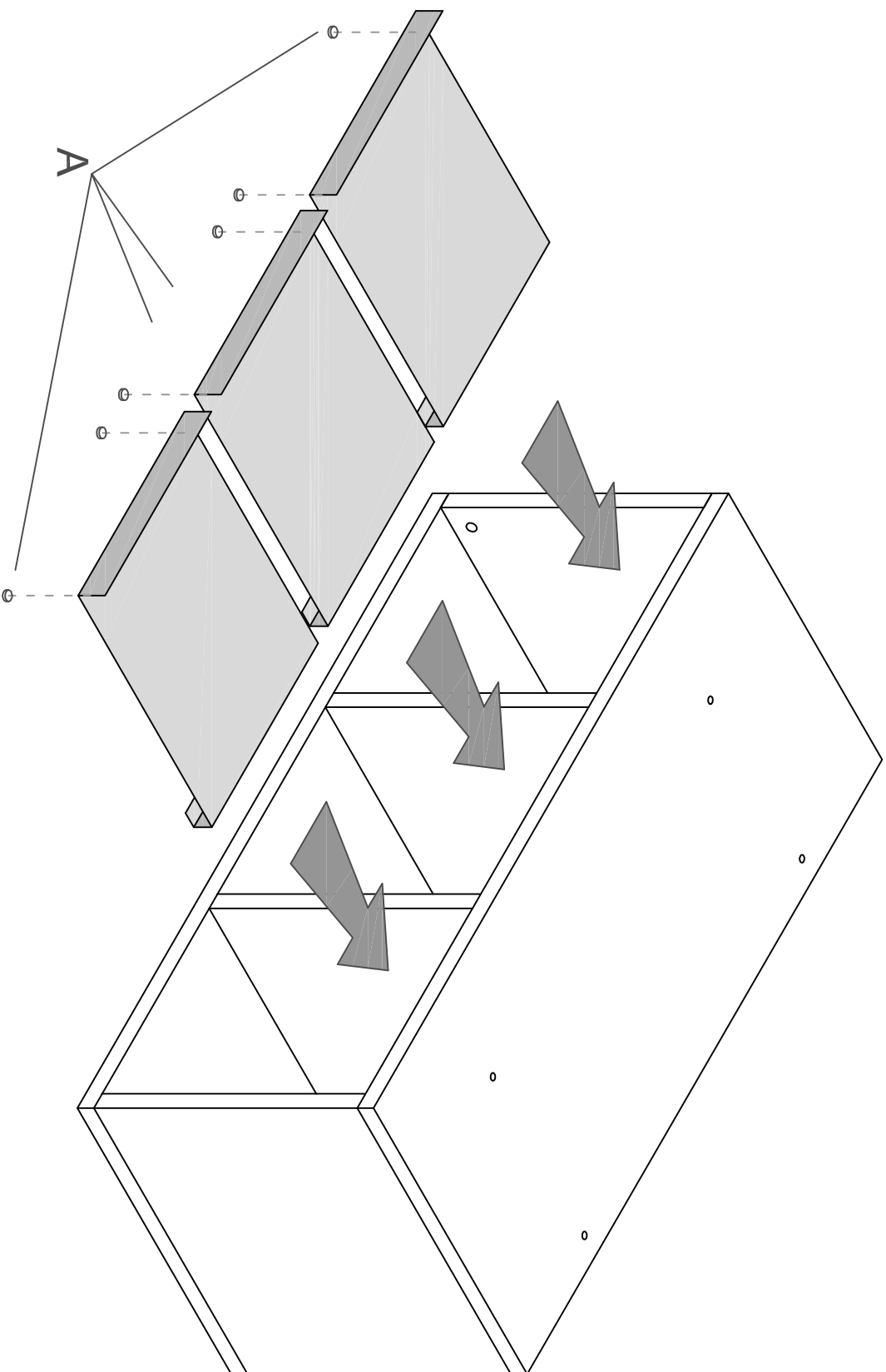

2

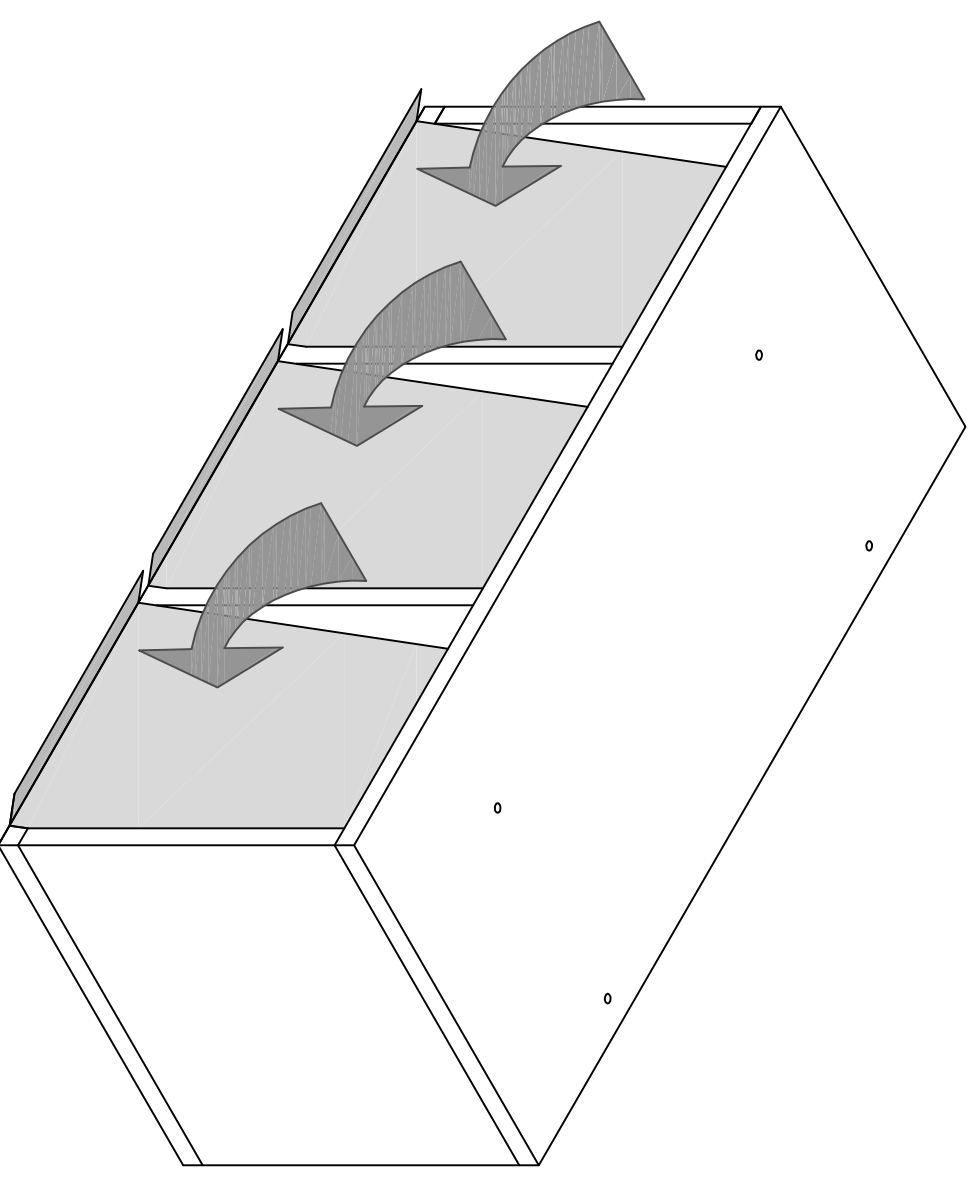

Q.ty 4

A

butée

